

# OLYMPUS

Your Vision, Our Future

THE HiQ+ SERIES

## HiQ+

Bipolar and Monopolar Hand Instruments,  
Monopolar HF Electrodes, Suction and Irrigation, Needle Holders



# CONTENTS

## **FORM FOLLOWS FUNCTION FOLLOWS YOUR NEEDS**

HiQ+ Bipolar.....	4
HiQ+ Monopolar and Standard.....	6
HiQ+ Suction and Irrigation.....	8
HiQ+ Needle Holders .....	9

## **TECHNICAL DATA**

5 mm Bipolar Forceps.....	10
5 mm Grasping Forceps .....	11
5 mm Dissection Forceps .....	14
5 mm Biopsy Forceps .....	15
5 mm Monopolar Scissors.....	16
10 mm Hand Instruments .....	17
Monopolar and Standard Spare Parts .....	18
Monopolar HF Electrodes .....	19
Suction and Irrigation.....	20
Knot Pushers.....	22
Needle Holders.....	23

# BIPOLAR SAFETY WITH “MONOPOLAR” PRECISION



## HiQ+ BIPOLAR

The Olympus HiQ+ bipolar series combines the safety benefits of bipolar technology with the precision and tactility of monopolar hand instruments. HiQ+ bipolar hand instruments are designed for safe and reliable coagulation with the ability of strong grasping and dissecting.

The HiQ+ bipolar series – a new standard for:

- Gynecology
- General Surgery
- Urology



### RELIABLE COAGULATION

HiQ+ bipolar is designed for reliable coagulation even in challenging situations. Coagulation of small vessels or stopping of sudden bleedings where joints may become covered with blood can be performed smoothly and reliably thanks to the unique joint insulation.

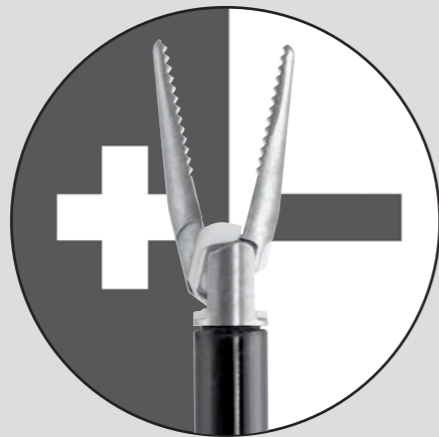

### BIPOLAR SAFETY

Bipolar instruments are known to be safer than monopolar devices as the electrical current flows directly between the instrument jaws, thus eliminating the need for a patient plate.

- Better control through focussed current flow within the surgeon's direct field of view.
- Reduces the risk of unpredictable current flow through the patient's body.
- Eliminates risk of injuries through malpositioning of the patient plate.



### STRONG GRASPING AND DISSECTION

Just as their monopolar counterparts, HiQ+ bipolar instruments are designed for high performance during grasping and dissecting – but with bipolar safety. HiQ+ bipolar replaces monopolar instruments even in procedures where strong grasping is required.



### EASY REPROCESSING

The modular three part design and the “easy click” mechanism of HiQ+ bipolar instruments allow easy assembly and disassembly. HiQ+ bipolar instruments are autoclavable to meet high demands regarding sterilisation and disinfection.

# FORM FOLLOWS FUNCTION

# FOLLOWS YOUR NEEDS



Force Transmission Diagram

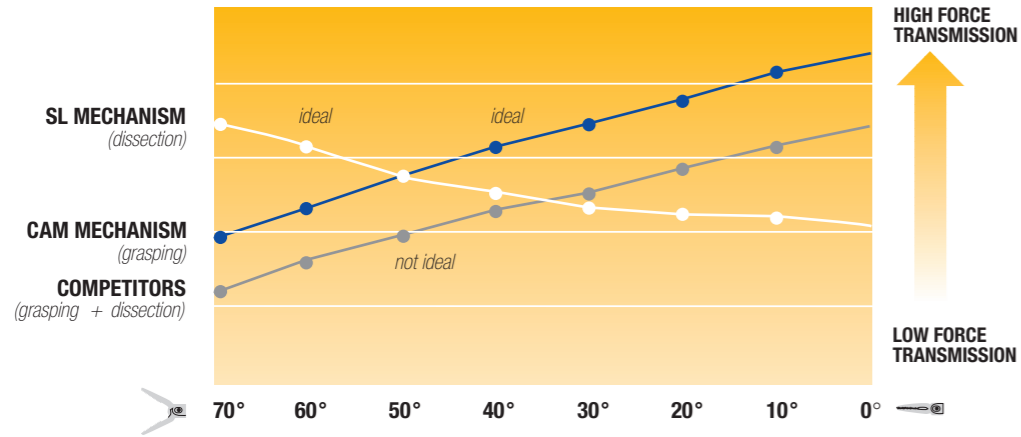

**Optimized force transmission for both, grasping and dissecting.**

**Grasping:** The CAM joint mechanism enables maximum force transmission during closure of the jaws, ensuring strong and precise control with minimal effort.

**Dissecting:** The SL joint mechanism enables maximum force transmission during opening of the jaws, ensuring strong and precise tissue separation with minimal effort.

## HiQ+ MONOPOLAR AND STANDARD

Tailored to be an ideal extension of the surgeon's hands.

- Strong but precise jaws control – for grasping, cutting and dissecting
- Streamlined handle for a perfect fit
- Multiple hand positions for continuously changing surgical needs



### STRONG AND PRECISE

Surgeons demand strong and precise jaws performance in all applications. Olympus engineers developed two dedicated joint mechanisms to give the surgeon perfect tissue control: The CAM mechanism for grasping and the SL mechanism for dissecting.

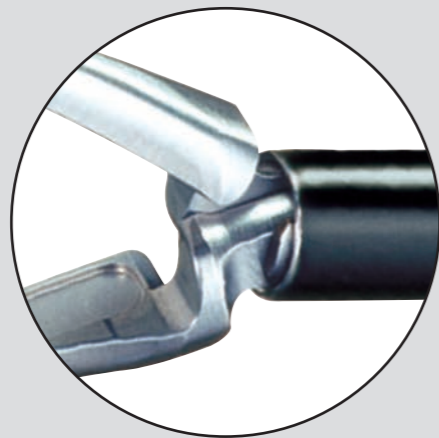

### RELIABLE AND SAFE

The extended insulation allows for safe and reliable performance during HF application. Both joint designs – CAM and SL – operate without protruding parts, which are a potential source of HF leakage in conventional cross-joints.



### THE "EASY CLICK" MECHANISM

Assembly and disassembly is easy allowing quicker preparation of the instrument for surgical use and reprocessing. The HiQ+ "easy-click" mechanism minimizes the time and effort of assembly and disassembly.



### OPTIMIZED ERGONOMICS

Surgeons depend on laparoscopic instrumentation day in and day out. Early fatigue and nerve damage have been reported from the use of conventional laparoscopic hand instruments.



Olympus designed HiQ+ handles for superior ergonomics and comfort. The smooth curved handle shape provides extra comfort while enabling multiple hand positions, tailored to a variety of laparoscopic procedures and anatomies.



hamburgunddesign 1999



design award winner 2003

# SUCTION AND IRRIGATION



## CLOG-FREE OPERATION

The HiQ+ suction/irrigation system is optimized for streamlined flow throughout all components, from inflow to outflow, thus enabling enhanced passage of immersed blood clots or stones. The modular system with a range of suction/irrigation tubes offers tailored solutions for a variety of laparoscopic procedures and anatomies. The HiQ suction/irrigation system combines excellent performance with surgeon-specific ergonomics and superior quality.



# NEEDLE HOLDERS



## STRONG AND DURABLE

The HiQ+ needle holders and knot pushers are a series of instruments designed to meet the highest expectations of functionality, ergonomics, and reprocessing.



Baden-Württemberg International Design Award 2004



reddot design award winner 2005



## CUSTOMIZABLE SYSTEM

Olympus offers a wide range of suction/irrigation tubes for its HiQ+ system:

- Diameters of 3, 5 and 10 mm
- Working lengths of 360 and 450 mm
- Multiple tip designs, e.g. for harvesting lost gall bladder stones or aspirating hydrops



## OPTIMIZED ERGONOMICS

Choice of two ergonomically designed handles for differing irrigation needs:

- Active handle with finger tip lever controlled suction/irrigation
- Passive handle with foot switch control in combination with pumps



## EASY REPROCESSING

The HiQ+ suction/irrigation system is designed for easy assembly, disassembly and cleaning. All components are easily detachable and autoclavable.

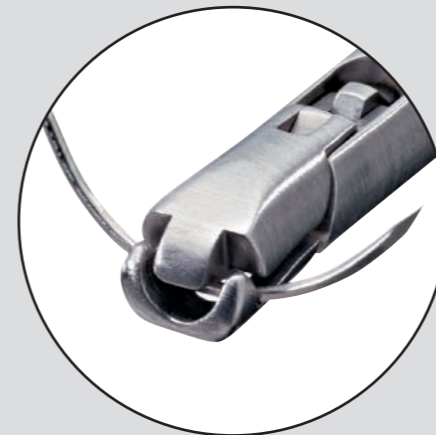

## STRONG AND DURABLE

The HiQ+ needle holders are engineered for:

- High grasping strength
- High accuracy to ensure precise and reliable control of the needle
- High durability with hard-metal inlays in the jaws



## EXCHANGEABLE JAWS INSERTS

The HiQ+ needle holder is available with five interchangeable jaws:

- Straight needle holder
  - Left-/right-curved needle holder
  - Self-aligning needle holder
  - Assistant needle holder
- The modular design permits easy assembly, disassembly and cleaning. All parts are autoclavable.



## OPTIMIZED ERGONOMICS

The HiQ+ needle holder handle meets the highest ergonomic demands. Olympus engineers work closely together with experts in ergonomics to design the handle as “a part of the surgeon’s hand”.

# 5 MM BIPOLAR FORCEPS

## Johann Forceps

Multipurpose forceps for strong grasping and atraumatic dissection for all laparoscopic procedures



Grasping forceps, fenestrated, length of jaws: 16.5 mm, bipolar,

WA63120C 330 mm, Ergo handle  
WA63121C 430 mm, Ergo handle

### Components

WA64120C Jaws insert, 330 mm working length  
WA64121C Jaws insert, 430 mm working length  
WA60800C Shaft, 330 mm working length  
WA60801C Shaft, 430 mm working length  
WA60101C Handle "Ergo", bipolar

## Straight Forceps

Multipurpose straight dissection forceps for all laparoscopic procedures



Dissection forceps, straight, length of jaws: 12.7 mm, bipolar,

WA63310C 330 mm, Ergo handle  
WA63311C 430 mm, Ergo handle

### Components

WA64310C Jaws insert, 330 mm working length  
WA64311C Jaws insert, 430 mm working length  
WA60800C Shaft, 330 mm working length  
WA60801C Shaft, 430 mm working length  
WA60101C Handle "Ergo", bipolar

## Hirsch Forceps

For tubal sterilization and endometriosis treatment



Grasping forceps, Hirsch, length of jaws: 19.7 mm, bipolar,

WA63200C 330 mm, Ergo handle  
WA63201C 430 mm, Ergo handle

### Components

WA64200C Jaws insert, 330 mm working length  
WA64201C Jaws insert, 430 mm working length  
WA60800C Shaft, 330 mm working length  
WA60801C Shaft, 430 mm working length  
WA60101C Handle "Ergo", bipolar

## Maryland

Multipurpose curved dissection forceps for all laparoscopic procedures



Dissection forceps, Maryland, length of jaws: 14.7 mm, bipolar,

WA63320C 330 mm, Ergo handle  
WA63321C 430 mm, Ergo handle

### Components

WA64320C Jaws insert, 330 mm working length  
WA64321C Jaws insert, 430 mm working length  
WA60800C Shaft, 330 mm working length  
WA60801C Shaft, 430 mm working length  
WA60101C Handle "Ergo", bipolar

## Tweezers

For very delicate dissection and coagulation



Dissection forceps, tweezers, length of jaws: 17.2 mm, bipolar,

WA63210C 330 mm, Ergo handle  
WA63211C 430 mm, Ergo handle

### Components

WA64210C Jaws insert, 330 mm working length  
WA64211C Jaws insert, 430 mm working length  
WA60800C Shaft, 330 mm working length  
WA60801C Shaft, 430 mm working length  
WA60101C Handle "Ergo", bipolar

## Manhes Forceps

Grasping forceps for myomectomy and cystectomy



Grasping forceps, Manhes, length of jaws: 14 mm, bipolar,

WA63050C 330 mm, Ergo handle  
WA63051C 430 mm, Ergo handle

### Components

WA64050C Jaws insert, 330 mm working length  
WA64051C Jaws insert, 430 mm working length  
WA60800C Shaft, 330 mm working length  
WA60801C Shaft, 430 mm working length  
WA60101C Handle "Ergo", bipolar

## System Chart

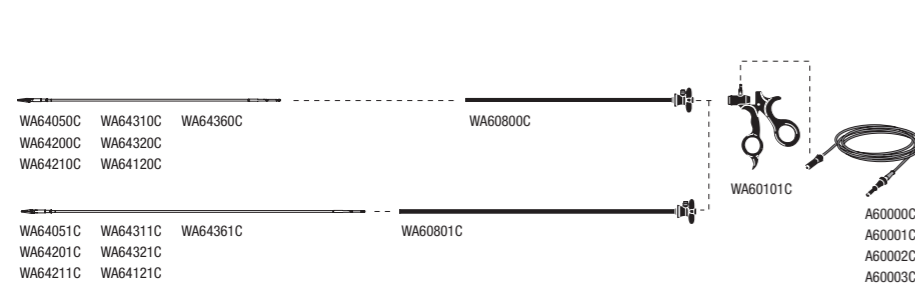

## Fine Maryland Forceps

Due to increased branch length the jaws allow improved overview and handling. Suitable for kidney resection and adrenalectomy.



Dissection forceps, Maryland, length of jaws: 19 mm, bipolar

WA63360C 330 mm, Ergo handle  
WA63361C 430 mm, Ergo handle

### Components

WA64360C Jaws insert, 330 mm working length  
WA64361C Jaws insert, 430 mm working length  
WA60800C Shaft, 330 mm working length  
WA60801C Shaft, 430 mm working length  
WA60101C Handle "Ergo", bipolar

# 5 MM GRASPING FORCEPS

## HiQ+ Bipolar Components

WA60101C Handle "Ergo", bipolar



WA60800C Shaft, insulated, bipolar, 5 x 330 mm



WA60801C Shaft, insulated, bipolar, 5 x 430 mm



A03441A Spare release button, 10 pcs., for HiQ+ shafts



A60003C HF cable, bipolar, 3.5 m length, for UES-20/-30/-40, and Valleylab HF units for Erbe International HF units for Martin and Berchtold HF units for HF-300, Erbe T series, and Erbe ACC/ICC/VIO\* HF units

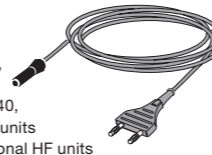

\* Depending on individual connector configuration

## Atraumatic Grasping Forceps

Multi-purpose grasping forceps for all laparoscopic applications



Grasping forceps, atraumatic, length of jaws: 16 mm,

A63010S 250 mm, Ergo handle, ratchet  
A63010A 330 mm, Ergo handle, ratchet  
A63010L 430 mm, Ergo handle, ratchet  
WA63012A 330 mm, Ergo handle, monopolar, deactivatable ratchet

A63013S 250 mm, Ergo S handle, ratchet  
A63013A 330 mm, Ergo S handle, ratchet  
A63013L 430 mm, Ergo S handle, ratchet  
WA63014A 330 mm, Ergo S handle, monopolar, deactivatable ratchet

### Components

A64010S Jaws insert, 250 mm working length  
A64010A Jaws insert, 330 mm working length  
A64010L Jaws insert, 430 mm working length  
A60800S Shaft, 250 mm working length  
A60800A Shaft, 330 mm working length  
A60800L Shaft, 430 mm working length  
A60100A Handle "Ergo", ratchet  
WA60115A Handle "Ergo", monopolar, deactivatable ratchet  
A60200A Handle "Ergo S", ratchet  
WA60205A Handle "Ergo S", monopolar, deactivatable ratchet

## Claw Forceps

For recovery of e.g. gall bladder, myoma, etc.



Grasping forceps, claw type, length of jaws: 28 mm, 330 mm, Ergo handle, ratchet

WA63020A 330 mm, Ergo handle, monopolar, deactivatable ratchet  
WA63022A 330 mm, Ergo handle, monopolar, deactivatable ratchet  
A63023A 330 mm, Ergo S handle, ratchet  
WA63024A 330 mm, Ergo S handle, monopolar, deactivatable ratchet

### Components

WA64020S Jaws insert, 250 mm working length  
A64020A Jaws insert, 330 mm working length  
WA64020L Jaws insert, 430 mm working length  
A60800S Shaft, 250 mm working length  
A60800A Shaft, 330 mm working length  
A60800L Shaft, 430 mm working length  
A60100A Handle "Ergo", ratchet  
WA60115A Handle "Ergo", monopolar, deactivatable ratchet  
A60200A Handle "Ergo S", ratchet  
WA60205A Handle "Ergo S", monopolar, deactivatable ratchet

## Flat Grasping Forceps

Multi-purpose fenestrated grasping forceps for all laparoscopic applications



Grasping forceps, atraumatic, flat, length of jaws: 19 mm,

A63030A 330 mm, Ergo handle, ratchet  
WA63032A 330 mm, Ergo handle, monopolar, deactivatable ratchet  
A63033A 330 mm, Ergo S handle, ratchet  
WA63034A 330 mm, Ergo S handle, monopolar, deactivatable ratchet

### Components

WA64030S Jaws insert, 250 mm working length  
A64030A Jaws insert, 330 mm working length  
WA64030L Jaws insert, 430 mm working length  
A60800S Shaft, 250 mm working length  
A60800A Shaft, 330 mm working length  
A60800L Shaft, 430 mm working length  
A60100A Handle "Ergo", ratchet  
WA60115A Handle "Ergo", monopolar, deactivatable ratchet  
A60200A Handle "Ergo S", ratchet  
WA60205A Handle "Ergo S", monopolar, deactivatable ratchet

## Grasping Forceps with Lumen

Atraumatic grasping forceps for delicate tissue manipulation (e.g. bowel, tubes)



Grasping forceps, with lumen, length of jaws: 21 mm,

A63040A 330 mm, Ergo handle, ratchet  
WA63042A 330 mm, Ergo handle, monopolar, deactivatable ratchet  
A63043A 330 mm, Ergo S handle, ratchet  
WA63044A 330 mm, Ergo S handle, monopolar, deactivatable ratchet

### Components

WA64040S Jaws insert, 250 mm working length  
A64040A Jaws insert, 330 mm working length  
WA64040L Jaws insert, 430 mm working length  
A60800S Shaft, 250 mm working length  
A60800A Shaft, 330 mm working length  
A60800L Shaft, 430 mm working length  
A60100A Handle "Ergo", ratchet  
WA60115A Handle "Ergo", monopolar, deactivatable ratchet  
A60200A Handle "Ergo S", ratchet  
WA60205A Handle "Ergo S", monopolar, deactivatable ratchet

# 5 MM GRASPING FORCEPS

## Manhes Forceps

Precise fixation and manipulation of fragile tissue



Grasping forceps, Manhes,

- length of jaws: 18 mm,
- A63050A 330 mm, Ergo handle, ratchet
- WA63052A 330 mm, Ergo handle, monopolar, deactivatable ratchet
- A63053A 330 mm, Ergo S handle, ratchet
- WA63054A 330 mm, Ergo S handle, monopolar, deactivatable ratchet

### Components

- A64050A Jaws insert, 330 mm working length
- WA64050L Jaws insert, 430 mm working length
- A60800A Shaft, 330 mm working length
- A60800L Shaft, 430 mm working length
- A60100A Handle "Ergo", ratchet
- WA60115A Handle "Ergo", monopolar, deactivatable ratchet
- A60200A Handle "Ergo S", ratchet
- WA60205A Handle "Ergo S", monopolar,

## Crocodile Forceps

For strong and tight fixation of tissue (e.g. stomach, gall bladder)



Grasping forceps, crocodile type,

- length of jaws: 18 mm,
- A63070A 330 mm, Ergo handle, ratchet
- WA63072A 330 mm, Ergo handle, monopolar, deactivatable ratchet
- A63073A 330 mm, Ergo S handle, ratchet
- WA63074A 330 mm, Ergo S handle, monopolar, deactivatable ratchet

### Components

- A64070A Jaws insert, 330 mm working length
- WA64070L Jaws insert, 430 mm working length
- A60800A Shaft, 330 mm working length
- A60800L Shaft, 430 mm working length
- A60100A Handle "Ergo", ratchet
- WA60115A Handle "Ergo", monopolar, deactivatable ratchet
- A60200A Handle "Ergo S", ratchet
- WA60205A Handle "Ergo S", monopolar, deactivatable ratchet

## Wave Type Grasping Forceps

Dedicated grasping forceps for bowel and fragile tissue



Grasping forceps, wave type, atraumatic,

- length of jaws: 30 mm,
- A63080A 330 mm, Ergo handle, ratchet
- WA63082A 330 mm, Ergo handle, monopolar, deactivatable ratchet
- A63083A 330 mm, Ergo S handle, ratchet
- WA63084A 330 mm, Ergo S handle, monopolar, deactivatable ratchet

### Components

- A64080A Jaws insert, 330 mm working length
- WA64080L Jaws insert, 430 mm working length
- A60800A Shaft, 330 mm working length
- A60800L Shaft, 430 mm working length
- A60100A Handle "Ergo", ratchet
- WA60115A Handle "Ergo", monopolar, deactivatable ratchet
- A60200A Handle "Ergo S", ratchet
- WA60205A Handle "Ergo S", monopolar, deactivatable ratchet

## Babcock Forceps

Widest inner lumen of all 5 mm HiQ+ hand instruments, "paddle" design for maximum grasping performance without damage of tissue (e.g. colon)

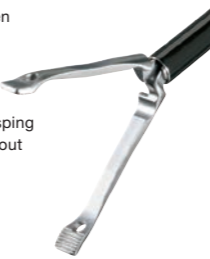

Grasping forceps, Babcock,

- length of jaws: 31 mm,
- WA63140A 330 mm, Ergo handle, ratchet
- WA63142A 330 mm, Ergo handle, monopolar, deactivatable ratchet
- WA63143A 330 mm, Ergo S handle, ratchet
- WA63144A 330 mm, Ergo S handle, monopolar, deactivatable ratchet

### Components

- WA64140A Jaws insert, 330 mm working length
- WA64140L Jaws insert, 430 mm working length
- A60800A Shaft, 330 mm working length
- A60800L Shaft, 430 mm working length
- A60100A Handle "Ergo", ratchet
- WA60115A Handle "Ergo", monopolar, deactivatable ratchet
- A60200A Handle "Ergo S", ratchet
- WA60205A Handle "Ergo S", monopolar, deactivatable ratchet

## Johann Forceps

Multi-purpose grasping forceps with large jaws and good visibility



Grasping forceps, Johann, fenestrated,

- length of jaws: 24 mm,
- A63120S 250 mm, Ergo handle, ratchet
- A63120A 330 mm, Ergo handle, ratchet
- WA63120L 430 mm, Ergo handle, ratchet
- WA63122A 330 mm, Ergo handle, monopolar, deactivatable ratchet
- A63123S 250 mm, Ergo S handle, ratchet
- A63123A 330 mm, Ergo S handle, ratchet
- WA63123L 430 mm, Ergo S handle, ratchet
- WA63124A 330 mm, Ergo S handle, monopolar, deactivatable ratchet

### Components

- A64120S Jaws insert, 250 mm working length
- A64120A Jaws insert, 330 mm working length
- WA64120L Jaws insert, 430 mm working length
- A60800S Shaft, 250 mm working length
- A60800A Shaft, 330 mm working length
- A60800L Shaft, 430 mm working length
- A60100A Handle "Ergo", ratchet
- WA60115A Handle "Ergo", monopolar, deactivatable ratchet
- A60200A Handle "Ergo S", ratchet
- WA60205A Handle "Ergo S", monopolar, deactivatable ratchet

## Long Johann Forceps

Longest jaws in the 5 mm line of HiQ+ hand instruments for atraumatic grasping of larger organs (e.g. colon)



Grasping forceps, Johann, long,

- length of jaws: 40 mm,
- WA63130A 330 mm, Ergo handle, ratchet
- WA63132A 330 mm, Ergo handle, monopolar, deactivatable ratchet
- WA63133A 330 mm, Ergo S handle, ratchet
- WA63134A 330 mm, Ergo S handle, monopolar, deactivatable ratchet

### Components

- WA64130A Jaws insert, 330 mm working length
- WA64130L Jaws insert, 430 mm working length
- A60800A Shaft, 330 mm working length
- A60800L Shaft, 430 mm working length
- A60100A Handle "Ergo", ratchet
- WA60115A Handle "Ergo", monopolar, deactivatable ratchet
- A60200A Handle "Ergo S", ratchet
- WA60205A Handle "Ergo S", monopolar, deactivatable ratchet

# 5 MM GRASPING FORCEPS

## Johann Single-Action Forceps

The single-action mechanism offers improved handling in limited operation areas and allows an atraumatic and firm grasping of soft tissue (e.g. colon).



Grasping forceps, Johann, single action,

- length of jaws: 24 mm,
- WA63190A 330 mm, Ergo handle, ratchet
- WA63190L 430 mm, Ergo handle, ratchet
- WA63192A 330 mm, Ergo handle, monopolar, deactivatable ratchet
- WA63193A 330 mm, Ergo S handle, ratchet
- WA63193L 430 mm, Ergo S handle, ratchet
- WA63194A 330 mm, Ergo S handle, monopolar, deactivatable ratchet

### Components

- WA64190A Jaws insert, 330 mm working length
- WA64190L Jaws insert, 430 mm working length
- A60800A Shaft, 330 mm working length
- A60800L Shaft, 430 mm working length
- A60100A Handle "Ergo", ratchet
- WA60115A Handle "Ergo", monopolar, deactivatable ratchet
- A60200A Handle "Ergo S", ratchet
- WA60205A Handle "Ergo S", monopolar, deactivatable ratchet

## CroceOlmi Grasping Forceps

Allows through a special jaws design the grasping and refixation of the tissue out of the hernia sac and bowel manipulation.



Grasping forceps, CroceOlmi,

- length of jaws: 29 mm,
- WA63150A 330 mm, Ergo handle, monopolar
- WA63150L 430 mm, Ergo handle, monopolar
- WA63152A 330 mm, Ergo handle, monopolar, deactivatable ratchet
- WA63153A 330 mm, Ergo S handle, ratchet
- WA63153L 430 mm, Ergo S handle, monopolar
- WA63154A 330 mm, Ergo S handle, monopolar, deactivatable ratchet

### Components

- WA64150A Jaws insert, 330 mm working length
- WA64150L Jaws insert, 430 mm working length
- A60800A Shaft, 330 mm working length
- A60800L Shaft, 430 mm working length
- A60100A Handle "Ergo", ratchet
- A60101A Handle "Ergo", monopolar
- WA60115A Handle "Ergo", monopolar, deactivatable ratchet
- A60200A Handle "Ergo S", ratchet
- A60201A Handle "Ergo S", monopolar
- WA60205A Handle "Ergo S", monopolar, deactivatable ratchet

## DeBakey Grasping Forceps

Fine toothed jaws design and long jaws allow atraumatic grasping of the bowel and other delicate tissue.



Grasping forceps, DeBakey,

- length of jaws: 35 mm,
- WA63160A 330 mm, Ergo handle, monopolar, ratchet
- WA63160L 430 mm, Ergo handle, monopolar
- WA63162A 330 mm, Ergo handle, monopolar, deactivatable ratchet
- WA63163A 330 mm, Ergo S handle, ratchet
- WA63163L 430 mm, Ergo S handle, monopolar
- WA63164A 330 mm, Ergo S handle, monopolar, deactivatable ratchet

### Components

- WA64160A Jaws insert, 330 mm working length
- WA64160L Jaws insert, 430 mm working length
- A60800A Shaft, 330 mm working length
- A60800L Shaft, 430 mm working length
- A60100A Handle "Ergo", ratchet
- A60101A Handle "Ergo", monopolar
- A60102A Handle "Ergo", monopolar, ratchet
- WA60115A Handle "Ergo", monopolar, deactivatable ratchet
- A60200A Handle "Ergo S", ratchet
- A60201A Handle "Ergo S", monopolar
- WA60205A Handle "Ergo S", monopolar, deactivatable ratchet

## Atraumatic Forceps with Lumen

Due to inner lumen and short overall length the jaws provide a good atraumatic grip. The lumen creates a tweezer effect. Both the atraumatic grip and the tweezer effect are perfect for perpendicular grasping as needed in the endometriosis treatment.



Grasping forceps, atraumatic, lumen,

- length of jaws: 16 mm,
- WA63170A 330 mm, Ergo handle, monopolar
- WA63172A 330 mm, Ergo handle, monopolar, deactivatable ratchet
- WA63173A 330 mm, Ergo S handle, ratchet
- WA63174A 330 mm, Ergo S handle, monopolar, deactivatable ratchet

### Components

- WA64170A Jaws insert, 330 mm working length
- A60800A Shaft, 330 mm working length
- A60101A Handle "Ergo", monopolar
- WA60115A Handle "Ergo", monopolar, deactivatable ratchet
- A60200A Handle "Ergo S", ratchet
- WA60205A Handle "Ergo S", monopolar, deactivatable ratchet

## Clinching Forceps

Allows atraumatic, firm grasping of the gall bladder and other slippery tissue through its special tooth design. Mandatory jaws for cholecystectomy.



Grasping forceps, clinching,

- length of jaws: 26 mm,
- WA63180A 330 mm, Ergo handle, ratchet
- WA63182A 330 mm, Ergo handle, monopolar, deactivatable ratchet
- WA63183A 330 mm, Ergo S handle, ratchet
- WA63184A 330 mm, Ergo S handle, monopolar, deactivatable ratchet

### Components

- WA64180A Jaws insert, 330 mm working length
- A60800A Shaft, 330 mm working length
- A60100A Handle "Ergo", ratchet
- WA60115A Handle "Ergo", monopolar, deactivatable ratchet
- A60200A Handle "Ergo S", ratchet
- WA60205A Handle "Ergo S", monopolar, deactivatable ratchet

# 5 MM DISSECTION FORCEPS

## Dissection Forceps

For delicate dissection and needle holder assistance



Dissection forceps, straight, length of jaws: 15 mm,

- A63310S 250 mm, Ergo handle, monopolar
- A63310A 330 mm, Ergo handle, monopolar
- WA63312A 330 mm, Ergo handle, monopolar, deactivatable ratchet
- A63313S 250 mm, Ergo S handle, monopolar
- A63313A 330 mm, Ergo S handle, monopolar
- WA63314A 330 mm, Ergo S handle, monopolar, deactivatable ratchet

### Components

- A64310S Jaws insert, 250 mm working length
- A64310A Jaws insert, 330 mm working length
- WA64310L Jaws insert, 430 mm working length
- A60800S Shaft, 250 mm working length
- A60800A Shaft, 330 mm working length
- A60800L Shaft, 430 mm working length
- A60101A Handle "Ergo", monopolar
- WA60115A Handle "Ergo", monopolar, deactivatable ratchet
- A60201A Handle "Ergo S", monopolar
- WA60205A Handle "Ergo S", monopolar, deactivatable ratchet

## Short Maryland Forceps

For precise dissection and needle holder assistance



Dissection forceps, Maryland, short, length of jaws: 17 mm,

- A63340A 330 mm, Ergo handle, monopolar
- WA63342A 330 mm, Ergo handle, monopolar, deactivatable ratchet
- A63343A 330 mm, Ergo S handle, monopolar
- WA63344A 330 mm, Ergo S handle, monopolar, deactivatable ratchet

### Components

- WA64340S Jaws insert, 250 mm working length
- A64340A Jaws insert, 330 mm working length
- WA64340L Jaws insert, 430 mm working length
- A60800S Shaft, 250 mm working length
- A60800A Shaft, 330 mm working length
- A60800L Shaft, 430 mm working length
- A60101A Handle "Ergo", monopolar
- WA60115A Handle "Ergo", monopolar, deactivatable ratchet
- A60201A Handle "Ergo S", monopolar
- WA60205A Handle "Ergo S", monopolar, deactivatable ratchet

## Maryland Forceps

Multipurpose curved dissection forceps for all laparoscopic applications



Dissection forceps, Maryland, length of jaws: 21 mm,

- A63320S 250 mm, Ergo handle, monopolar
- A63320A 330 mm, Ergo handle, monopolar
- A63320L 430 mm, Ergo handle, monopolar
- WA63322A 330 mm, Ergo handle, monopolar, deactivatable ratchet
- A63323S 250 mm, Ergo S handle, monopolar
- A63323A 330 mm, Ergo S handle, monopolar
- A63323L 430 mm, Ergo S handle, monopolar
- WA63324A 330 mm, Ergo S handle, monopolar, deactivatable ratchet

### Components

- A64320S Jaws insert, 250 mm working length
- A64320A Jaws insert, 330 mm working length
- A64320L Jaws insert, 430 mm working length
- A60800S Shaft, 250 mm working length
- A60800A Shaft, 330 mm working length
- A60800L Shaft, 430 mm working length
- A60101A Handle "Ergo", monopolar
- WA60115A Handle "Ergo", monopolar, deactivatable ratchet
- A60201A Handle "Ergo S", monopolar
- WA60205A Handle "Ergo S", monopolar, deactivatable ratchet

## Maryland Forceps with Cross Tooth Pattern

The cross tooth surface design allows stronger grasping performance



Dissection forceps, Maryland, cross tooth pattern, length of jaws: 17 mm,

- WA63350A 330 mm, Ergo handle, monopolar
- WA63352A 330 mm, Ergo handle, monopolar, deactivatable ratchet
- WA63353A 330 mm, Ergo S handle, monopolar
- WA63354A 330 mm, Ergo S handle, monopolar, deactivatable ratchet

### Components

- WA64350S Jaws insert, 250 mm working length
- WA64350A Jaws insert, 330 mm working length
- WA64350L Jaws insert, 430 mm working length
- A60800S Shaft, 250 mm working length
- A60800A Shaft, 330 mm working length
- A60800L Shaft, 430 mm working length
- A60101A Handle "Ergo", monopolar
- WA60115A Handle "Ergo", monopolar, deactivatable ratchet
- A60201A Handle "Ergo S", monopolar
- WA60205A Handle "Ergo S", monopolar, deactivatable ratchet

## Right Angle Dissection Forceps

For blood vessel dissection



Dissection forceps, 90° angled, length of jaws: 18 mm,

- WA63330A 330 mm, Ergo handle, monopolar
- WA63332A 330 mm, Ergo handle, monopolar, deactivatable ratchet
- WA63333A 330 mm, Ergo S handle, monopolar
- WA63334A 330 mm, Ergo S handle, monopolar, deactivatable ratchet

### Components

- WA64330S Jaws insert, 250 mm working length
- WA64330A Jaws insert, 330 mm working length
- WA64330L Jaws insert, 430 mm working length
- A60800S Shaft, 250 mm working length
- A60800A Shaft, 330 mm working length
- A60800L Shaft, 430 mm working length
- A60101A Handle "Ergo", monopolar
- WA60115A Handle "Ergo", monopolar, deactivatable ratchet
- A60201A Handle "Ergo S", monopolar
- WA60205A Handle "Ergo S", monopolar, deactivatable ratchet

## Fine Maryland Forceps with Cross Tooth Pattern

Longer branch length improves the overview and handling. The cross tooth surface allows stronger grasping performance.



Dissection forceps, Maryland fine, cross tooth pattern, length of jaws: 19 mm,

- WA63370A 330 mm, Ergo handle, monopolar
- WA63372A 330 mm, Ergo handle, monopolar, deactivatable ratchet
- WA63373A 330 mm, Ergo S handle, monopolar
- WA63374A 330 mm, Ergo S handle, monopolar, deactivatable ratchet

### Components

- WA64370S Jaws insert, 250 mm working length
- WA64370A Jaws insert, 330 mm working length
- WA64370L Jaws insert, 430 mm working length
- A60800S Shaft, 250 mm working length
- A60800A Shaft, 330 mm working length
- A60800L Shaft, 430 mm working length
- A60101A Handle "Ergo", monopolar
- WA60115A Handle "Ergo", monopolar, deactivatable ratchet
- A60201A Handle "Ergo S", monopolar
- WA60205A Handle "Ergo S", monopolar, deactivatable ratchet

# 5 MM BIOPSY FORCEPS

## Biopsy Forceps

Biopsy forceps, with spike, length of jaws: 14 mm,

- A63610S 250 mm, Ergo handle, monopolar
- A63610A 330 mm, Ergo handle, monopolar
- A63610L 430 mm, Ergo handle, monopolar
- A63613S 250 mm, Ergo S handle, monopolar
- A63613A 330 mm, Ergo S handle, monopolar
- A63613L 430 mm, Ergo S handle, monopolar

### Components

- A64610S Jaws insert, 250 mm working length
- A64610A Jaws insert, 330 mm working length
- A64610L Jaws insert, 430 mm working length
- A60800S Shaft, 250 mm working length
- A60800A Shaft, 330 mm working length
- A60800L Shaft, 430 mm working length
- A60101A Handle "Ergo", monopolar
- A60201A Handle "Ergo S", monopolar

## Biopsy Forceps

Biopsy forceps, severing, length of jaws: 12 mm,

- A63620A 330 mm, Ergo handle, monopolar
- A63623A 330 mm, Ergo S handle, monopolar

### Components

- A64620A Jaws insert, 330 mm working length
- WA64620L Jaws insert, 430 mm working length
- A60800A Shaft, 330 mm working length
- A60800L Shaft, 430 mm working length
- A60101A Handle "Ergo", monopolar
- A60201A Handle "Ergo S", monopolar



# 5 MM MONOPOLAR SCISSORS

## Metzenbaum Scissors

Multipurpose scissors for all laparoscopic applications



Scissors, Metzenbaum, length of jaws: 19 mm,  
 A63810S 250 mm, Ergo handle, monopolar  
 A63810A 330 mm, Ergo handle, monopolar  
 A63810L 430 mm, Ergo handle, monopolar  
 A63813S 250 mm, Ergo S handle, monopolar  
 A63813A 330 mm, Ergo S handle, monopolar  
 A63813L 430 mm, Ergo S handle, monopolar

Components  
 A64810S Jaws insert, 250 mm working length  
 A64810A Jaws insert, 330 mm working length  
 A64810L Jaws insert, 430 mm working length  
 A60800S Shaft, 250 mm working length  
 A60800A Shaft, 330 mm working length  
 A60800L Shaft, 430 mm working length  
 A60101A Handle "Ergo", monopolar  
 A60201A Handle "Ergo S", monopolar

## Mini-Metzenbaum Scissors

For precise cutting and preparation



Scissors, Mini-Metzenbaum, length of jaws: 16 mm,  
 A63840A 330 mm, Ergo handle, monopolar  
 A63843A 330 mm, Ergo S handle, monopolar

Components  
 WA64840S Jaws insert, 250 mm working length  
 A64840A Jaws insert, 330 mm working length  
 WA64840L Jaws insert, 430 mm working length  
 A60800S Shaft, 250 mm working length  
 A60800A Shaft, 330 mm working length  
 A60800L Shaft, 430 mm working length  
 A60101A Handle "Ergo", monopolar  
 A60201A Handle "Ergo S", monopolar

## Hook Scissors

For cutting of sutures



Hook scissors, length of jaws: 12 mm,  
 A63820S 250 mm, Ergo handle, monopolar  
 A63820A 330 mm, Ergo handle, monopolar  
 A63820L 430 mm, Ergo handle, monopolar  
 A63823S 250 mm, Ergo S handle, monopolar  
 A63823A 330 mm, Ergo S handle, monopolar  
 A63823L 430 mm, Ergo S handle, monopolar

Components  
 A64820S Jaws insert, 250 mm working length  
 A64820A Jaws insert, 330 mm working length  
 A64820L Jaws insert, 430 mm working length  
 A60800S Shaft, 250 mm working length  
 A60800A Shaft, 330 mm working length  
 A60800L Shaft, 430 mm working length  
 A60101A Handle "Ergo", monopolar  
 A60201A Handle "Ergo S", monopolar

## Straight Scissors

Scissors, straight, length of jaws: 19 mm,



A63830A 330 mm, Ergo handle, monopolar  
 A63833A 330 mm, Ergo S handle, monopolar

Components  
 WA64830S Jaws insert, 250 mm working length  
 A64830A Jaws insert, 330 mm working length  
 WA64830L Jaws insert, 430 mm working length  
 A60800S Shaft, 250 mm working length  
 A60800A Shaft, 330 mm working length  
 A60800L Shaft, 430 mm working length  
 A60101A Handle "Ergo", monopolar  
 A60201A Handle "Ergo S", monopolar

## Single-Use Metzenbaum Scissors

WA64850A Scissors, Metzenbaum, length of jaws: 17 mm, Shaft insert, 330 mm working length, sterile, single-use, 6 pcs.



Reusable components  
 A60101A Handle "Ergo", monopolar  
 A60201A Handle "Ergo S", monopolar

# 10 MM HAND INSTRUMENTS

## Claw Forceps

For recoverage of e.g. gall bladder, myoma, etc.



Grasping forceps, claw type, length of jaws: 45 mm,  
 A65020A 330 mm, Ergo handle, ratchet  
 A65023A 330 mm, Ergo S handle, ratchet

Components  
 A66020A Jaws insert, 330 mm working length  
 A60900A Shaft, 330 mm working length  
 A60100A Handle "Ergo", ratchet  
 A60200A Handle "Ergo S", ratchet

## CBD Grasping Forceps

Soft-layered grasping forceps dedicated for manipulation of fragile tissue and flexible telescopes.



Grasping forceps, common bile duct (CBD), length of jaws: 16 mm,  
 A65070A 330 mm, Ergo handle, ratchet  
 A65073A 330 mm, Ergo S handle, ratchet

Components  
 A66070A Jaws insert, 330 mm working length  
 A60901A Shaft, 330 mm working length, tapered  
 A60100A Handle "Ergo", ratchet  
 A60200A Handle "Ergo S", ratchet

## Short Maryland Forceps

For precise dissection and needle holder assistance



Dissection forceps, Maryland, short, length of jaws: 24 mm,  
 A65320A 330 mm, Ergo handle, ratchet  
 A65323A 330 mm, Ergo S handle, ratchet

Components  
 A66320A Jaws insert, 330 mm working length  
 A60901A Shaft, 330 mm working length, tapered  
 A65060A 330 mm, Ergo handle, ratchet  
 A65063A 330 mm, Ergo S handle, ratchet

## Babcock Forceps

For manipulation of large fragile tissue (e.g. bowel, stomach, etc.)



Grasping forceps, Babcock, length of jaws: 47 mm,  
 A65050A 330 mm, Ergo handle, ratchet  
 A65053A 330 mm, Ergo S handle, ratchet

Components  
 A66050A Jaws insert, 330 mm working length  
 A60900A Shaft, 330 mm working length  
 A60100A Handle "Ergo", ratchet  
 A60200A Handle "Ergo S", ratchet

## Babcock Forceps (Atraumatic)

Widest inner lumen of all 10 mm HiQ+ hand instruments, "paddle" design for maximum grasping performance without damage of soft tissue (e.g. colon)



Grasping forceps, Babcock (atraumatic), length of jaws: 53 mm,  
 WA65040A 330 mm, Ergo handle, ratchet  
 WA65043A 330 mm, Ergo S handle, ratchet

Components  
 WA66040A Jaws insert, 330 mm working length  
 A60900A Shaft, 330 mm working length  
 A60100A Handle "Ergo", ratchet  
 A60200A Handle "Ergo S", ratchet

## Maryland Forceps

Multipurpose curved dissection forceps for all laparoscopic applications



Dissection forceps, Maryland, length of jaws: 30 mm,  
 A65310A 330 mm, Ergo handle, ratchet  
 A65313A 330 mm, Ergo S handle, ratchet

Components  
 A66310A Jaws insert, 330 mm working length  
 A60901A Shaft, 330 mm working length, tapered  
 A65060A 330 mm, Ergo handle, ratchet  
 A65063A 330 mm, Ergo S handle, ratchet

## Atraumatic Grasping Forceps

Dedicated grasping forceps for bowel and fragile tissue



Grasping forceps, wave type, atraumatic, length of jaws: 42 mm,  
 A65060A 330 mm, Ergo handle, ratchet  
 A65063A 330 mm, Ergo S handle, ratchet

Components  
 A66060A Jaws insert, 330 mm working length  
 A60900A Shaft, 330 mm working length  
 A60100A Handle "Ergo", ratchet  
 A60200A Handle "Ergo S", ratchet

# MONOPOLAR AND STANDARD SPARE PARTS

## HiQ+ Handles

A60100A	Handle "Ergo", with ratchet	
A60101A	Handle "Ergo", monopolar	
A60102A	Handle "Ergo", monopolar, with ratchet	
A60103A	Handle "Ergo"	
WA60115A	Handle "Ergo", monopolar, with deactivatable ratchet	
A60200A	Handle "Ergo S", ratchet, with silicone finger ring	
A60201A	Handle "Ergo S", monopolar, with silicone finger ring	
WA60205A	Handle "Ergo S", monopolar, deactivatable ratchet, with silicone finger ring	
A60210A	Handle "Semi inline S", with ratchet, with silicone finger ring	
A60211A	Handle "Semi inline S", monopolar, with silicone finger ring	

## Spare Parts

A0389	Finger ring, silicone, for HiQ+ S handles	
A03440A	Sealing cap, 2.2 mm, 10 pcs., for HiQ+ handles	
A03441A	Spare release button, 10 pcs., for HiQ+ shafts	
A03442A	Sealing ring, 20 pcs., for HiQ+ shafts	
A0358	HF cable, monopolar, 3.5 m length, for UES-40/-30, Erbe International and Valleylab (new)	
A0355	for UES-10/-20 and Valleylab (old)	
A0357	for Erbe T series, Martin, and Berchtold	

## 5 mm HiQ+ Shafts

A60800S	Shaft, insulated, 5 x 250 mm	
A60800A	Shaft, insulated, 5 x 330 mm	
A60800L	Shaft, insulated, 5 x 430 mm	

## 10 mm HiQ+ Shafts

A60900A	Shaft, insulated, straight, 10 x 330 mm	
A60901A	Shaft, insulated, tapered, 10 x 330 mm	

## System Chart

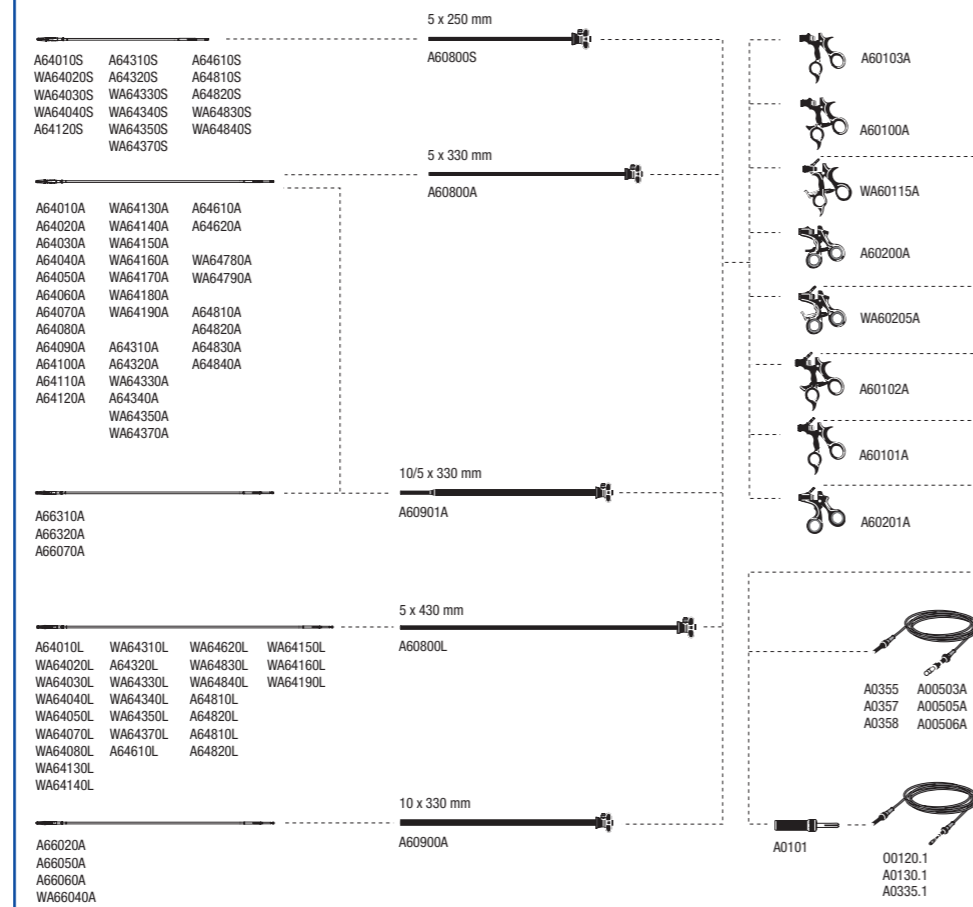

# MONOPOLAR HF ELECTRODES

## Monopolar HF Electrodes

A6280	HF electrode, button, 5 x 330 mm	
A6281	HF electrode, needle, 5 x 330 mm	
A6282	HF electrode, hook, 5 x 330 mm	
A6292	HF electrode, hook, with suction channel, 5 x 330 mm	
A6283	HF electrode, long hook, 5 x 330 mm	
A6289	HF electrode, long hook, 5 x 400 mm	
A6293	HF electrode, long hook, with suction channel, 5 x 330 mm	
A6299	HF electrode, long hook, with suction channel, 5 x 400 mm	
A6284	HF electrode, spoon, 5 x 330 mm	
A6294	HF electrode, spoon, with suction channel, 5 x 330 mm	

## Accessories for Monopolar HF Electrodes

A0308	Tubing, set, 6 x 10 mm, 3 m (transparent), 6 x 10 mm, 3 m (blue)	
O0103	Adapter, Luer lock male, tube connector	
A0358	HF cable, monopolar, 3.5 m length, for UES-40/-30, Erbe International and Valleylab (new)	
A0355	for UES-10/-20 and Valleylab (old)	
A0357	for Erbe T series, Martin, and Berchtold	



# SUCTION AND IRRIGATION

## Standard Suction/Irrigation System

Suction/irrigation tube, distal holes,  
 WA51111A 3.3 x 360 mm  
 WA51131A 5.3 x 360 mm  
 WA51131L 5.3 x 450 mm

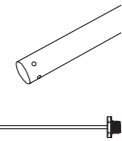

Suction/irrigation tube, aspiration cannula,  
 WA51132A 1.5 x 360 mm

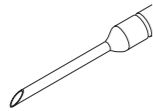

Suction/irrigation tube, button, monopolar,  
 WA51138A 5.3 x 360 mm



Handle, set, with suction control lever,  
 WA51172S includes WA51172A and WA51181S  
 To be used with pressure controlled roller pumps.

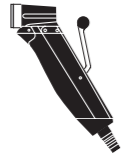

Handle, set, without suction control lever,  
 WA51173S includes WA51173A and WA51181S  
 To be used with foot switch

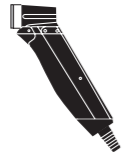

Handle, spare, with suction control lever  
 WA51172A  
 Handle, spare, without suction control lever  
 WA51173A



Tubing, spare, for HIQ+ handles,  
 WA51181S 5 mm suction channel



## Large Diameter Suction/Irrigation System

Suction/irrigation tube, distal holes,  
 WA51151A 10 x 360 mm  
 WA51151L 10 x 450 mm

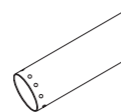

Suction/irrigation tube, safety basket,  
 WA51152A 10 x 360 mm

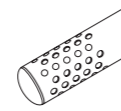

Suction/irrigation tube, stone collector,  
 WA51153A 10 x 360 mm

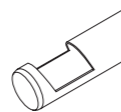

Handle, set, with suction control lever,  
 WA51172L includes WA51172A and WA51181L  
 To be used with pressure controlled roller pumps.

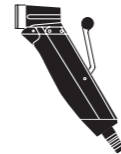

Handle, set, without suction control lever,  
 WA51173L includes WA51173A and WA51181L  
 To be used with foot switch

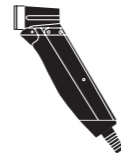

Handle, spare, with suction control lever  
 WA51172A  
 Handle, spare, without suction control lever  
 WA51173A



Tubing, spare, for HIQ+ handles,  
 WA51181L 8 mm suction channel



## Pump SurgiFlow

Pump "SurgiFlow",  
 WA58910A European set  
 WA58900A U.S. set



Delivery includes:  
 Pump, power cable, spare fuses,  
 tubing set WA58911A (only WA58910A9)

**Technical Data**  
 Power supply  
 Voltage ..... 100–240 V  
 Frequency ..... 50–60 Hz  
 Power consumption ..... 45 W  
 Size  
 Height ..... 93 mm  
 Width ..... 300 mm  
 Depth ..... 318 mm  
 Weight ..... 5 kg  
 Irrigation  
 Flow rate ..... 2500 ml/min  
 Max. pressure ..... 550 mm Hg  
 Safety  
 Protection ..... class I, type BF IPX 1

## Tubing

Tubing, set, for two water bags,  
 WA58901A for single use, sterile, 10 pcs.  
 WA58911A reusable, 1 pc.

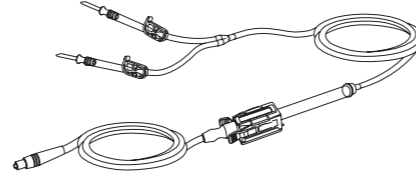

## System Chart Suction and Irrigation

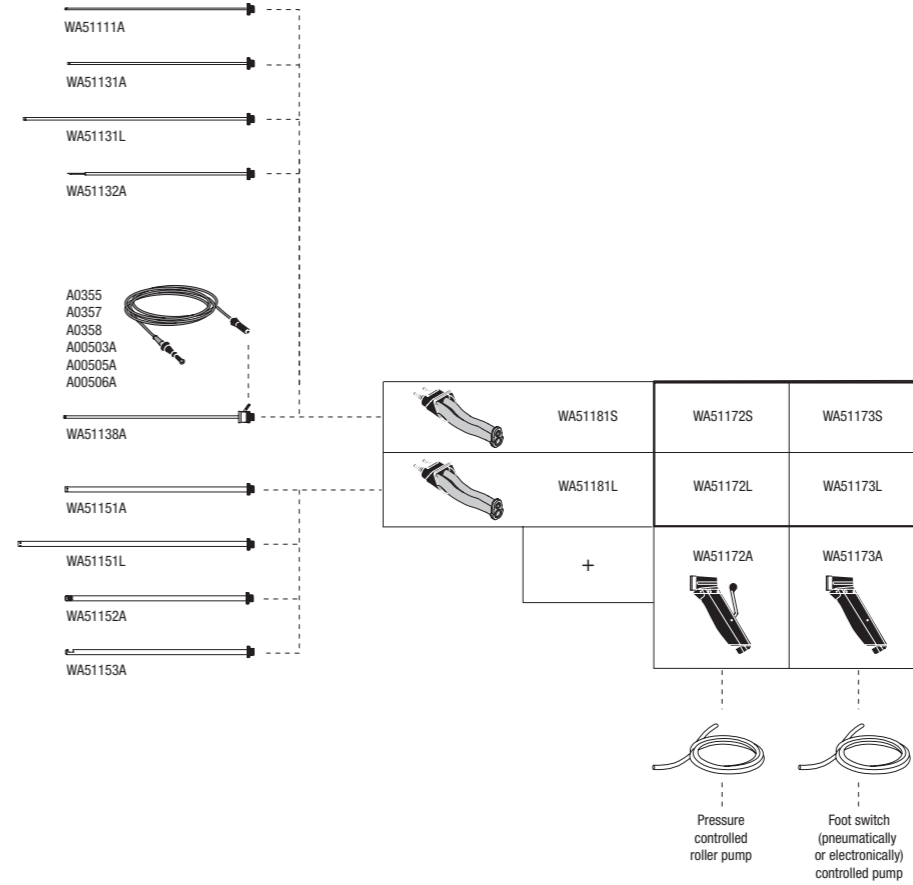

# KNOT PUSHERS

## HiQ+ Knot Pusher



WA63790A Knot pusher "HiQ+", 5 x 330 mm, Ergo handle, monopolar

Components

WA64790A Jaws insert, 330 mm working length  
A60800A Shaft, 330 mm working length  
A60101A Handle "Ergo", monopolar

## HiQ+ Roeder Knot Pusher



WA56903A Knot pusher, 5 x 330 mm

## HiQ+ Roeder Knot Pusher



WA63780A Knot pusher "HiQ+", Roeder, 5 x 330 mm, Ergo handle, monopolar

Components

WA64780A Jaws insert, 330 mm working length  
A60800A Shaft, 330 mm working length  
A60101A Handle "Ergo", monopolar

## Fascial Closure

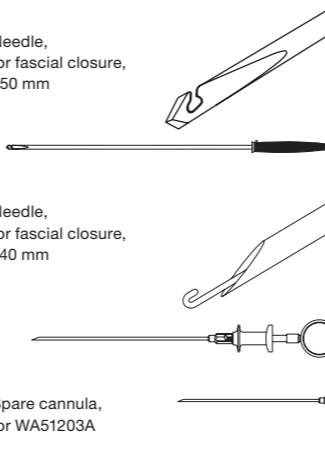

A51000A Needle, for fascial closure, 250 mm

WA51203A Needle, for fascial closure, 140 mm

WA51205A Spare cannula, for WA51203A

# NEEDLE HOLDERS

## Straight Needle Holder

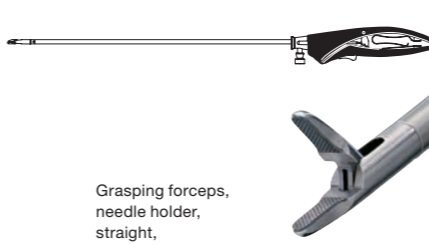

Grasping forceps, needle holder, straight, 5 mm,

WA63708A 330 mm, Inline A handle, ratchet  
WA63708L 430 mm, Inline A handle, ratchet

Components

WA64700A Jaws insert, 330 mm, for WA63708A  
WA64700L Jaws insert, 430 mm, for WA63708L  
WA60120A Handle, with sheath, 330 mm, ratchet  
WA60120L Handle, with sheath, 430 mm, ratchet

## Self-Alignment Needle Holder



Grasping forceps, needle holder, self-alignment, 5 mm,

WA63728A 330 mm, Inline A handle, ratchet  
WA63728L 430 mm, Inline A handle, ratchet

Components

WA64720A Jaws insert, 330 mm, for WA63728A  
WA64720L Jaws insert, 430 mm, for WA63728L  
WA60120A Handle, with sheath, 330 mm, ratchet  
WA60120L Handle, with sheath, 430 mm, ratchet

## HiQ+ Inline A Handles

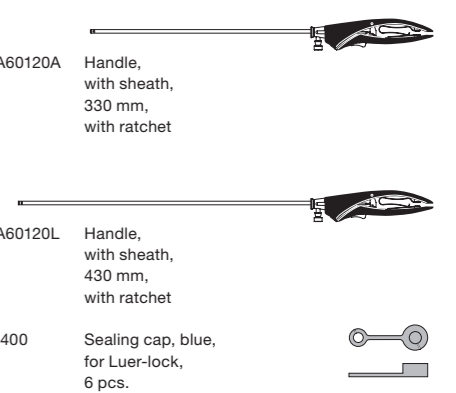

WA60120A Handle, with sheath, 330 mm, with ratchet

WA60120L Handle, with sheath, 430 mm, with ratchet

A0400 Sealing cap, blue, for Luer-lock, 6 pcs.

## Right-Curved Needle Holder

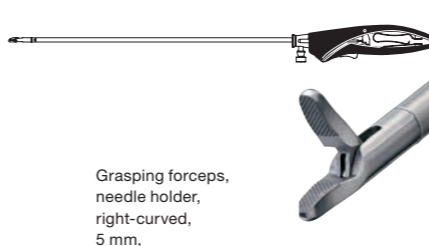

Grasping forceps, needle holder, right-curved, 5 mm,

WA63748A 330 mm, Inline A handle, ratchet  
WA63748L 430 mm, Inline A handle, ratchet

Components

WA64740A Jaws insert, 330 mm, for WA63748A  
WA64740L Jaws insert, 430 mm, for WA63748L  
WA60120A Handle, with sheath, 330 mm, ratchet  
WA60120L Handle, with sheath, 430 mm, ratchet

## Assistant Needle Holder



Grasping forceps, needle holder, assistant, 5 mm,

WA63758A 330 mm, Inline A handle, ratchet

Components

WA64750A Jaws insert, 330 mm, for WA63758A  
WA60120A Handle, with sheath, 330 mm, ratchet

## Standard Needle Holders

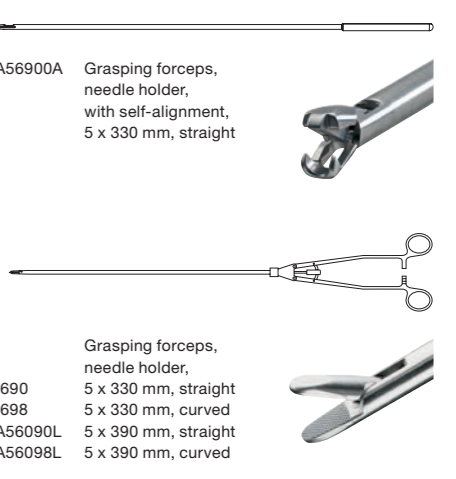

WA56900A Grasping forceps, needle holder, with self-alignment, 5 x 330 mm, straight

A5690 Grasping forceps, needle holder, 5 x 330 mm, straight

A5698 Grasping forceps, needle holder, 5 x 330 mm, curved

WA56090L Grasping forceps, needle holder, 5 x 390 mm, straight

WA56098L Grasping forceps, needle holder, 5 x 390 mm, curved

## Left-Curved Needle Holder

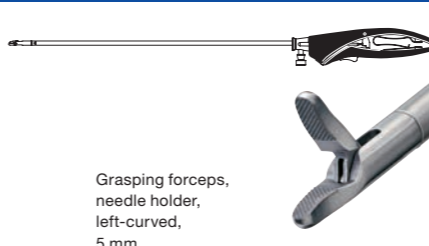

Grasping forceps, needle holder, left-curved, 5 mm,

WA63718A 330 mm, Inline A handle, ratchet  
WA63718L 430 mm, Inline A handle, ratchet

Components

WA64710A Jaws insert, 330 mm, for WA63718A  
WA64710L Jaws insert, 430 mm, for WA63718L  
WA60120A Handle, with sheath, 330 mm, ratchet  
WA60120L Handle, with sheath, 430 mm, ratchet

## Dolphin Type Needle Holder



Grasping forceps, needle holder, dolphin type, 5 mm,

WA63738A 330 mm, Inline A handle, ratchet  
WA63738L 430 mm, Inline A handle, ratchet

Components

WA64730A Jaws insert, 330 mm, for WA63738A  
WA64730L Jaws insert, 430 mm, for WA63738L  
WA60120A Handle, with sheath, 330 mm, ratchet  
WA60120L Handle, with sheath, 430 mm, ratchet

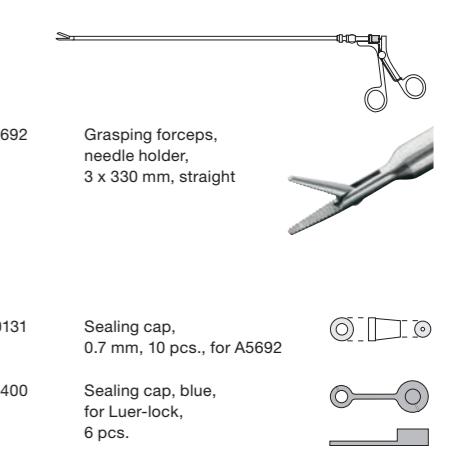

A5692 Grasping forceps, needle holder, 3 x 330 mm, straight

O0131 Sealing cap, 0.7 mm, 10 pcs., for A5692

A0400 Sealing cap, blue, for Luer-lock, 6 pcs.



Published by  
**OLYMPUS SURGICAL TECHNOLOGIES EUROPE**  
Olympus Winter & Ibe GmbH, Kuehnstraße 61, 22045 Hamburg, Germany

For a complete listing of  
sales and distribution locations visit:  
[www.olympus.com](http://www.olympus.com)